

料号 Part NO.	品名 Parts Name	A (MM)
34-LED-9.5	间隔柱 LED-9.5	9.5

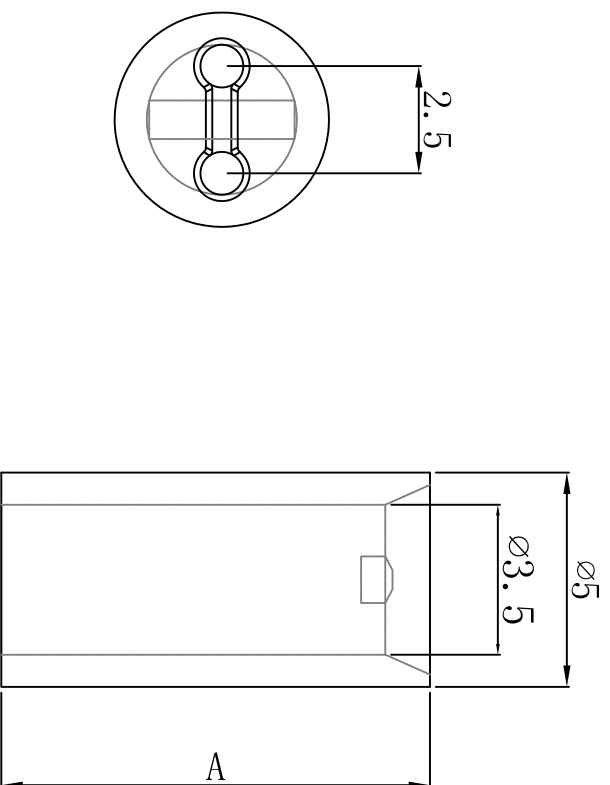

MATERIAL: NYLON 66 (UL)
 FLAME CLASS: 94V-2
 COLOR: NATUAL (白色)
 UNIT: mm

用途: 用于保护LED立于PC板上, 使高度一致, 中间隔板设计, 接脚不会弯曲、折断、短路。

公差要求: 未标注公差±0.3



未经并受权不得修改和复印
 该知识产权属于技术质量部;

DIMENSION	TOLERANCES	LTR.		NEW PART	DWG. BY	CHK. BY	DATE	DWG. BY	CHK. BY	DWG. NO.	UNIT
0.0 0.00	±0.3	A			<i>william</i>	<i>yan wang</i>	<i>2011/28</i>	<i>william</i>	<i>yan wang</i>	HIWA/QR-JZ-34-LED-9.5	mm
FIRST ANGLE PROJ											