

料号 Part NO.	品名 Parts Name
34-LCDS3-15	间隔柱

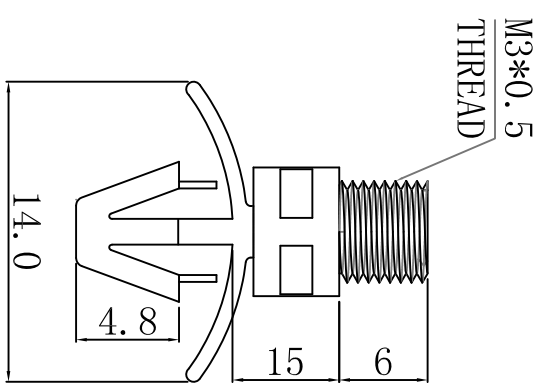

CHASSIS $\varnothing 4.8$
THICKNESS 0.8-2.5

材质: UL合格之 NYLON 66
防火等级94V-2。
颜色: 白色

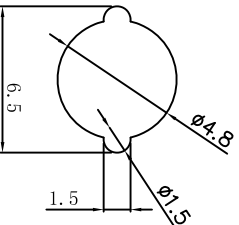

未经受权不得修改和复印
该知识产权属于技术质量部;

DIMENSION	TOLERANCES																		
0.0 0.00	± 0.5																		
PRIST ANGLE PROJ		A	NEW PART	<i>oullian</i>	<i>yu wang</i>	<i>20108</i>													
		LTR.	REVISION RECORD	DWG. BY	CHK. BY	DATE													
DWG. BY	<i>liu liang</i>	UNIT	mm	CHK. BY	<i>oullian</i>	REV.	A	APP. BY	<i>wang zhiyan</i>	DWG. NO.	HIWA/QR-JZ-34-LCDS3-15								
										HIMA 惠州惠华电子科技有限公司									